

MOVEMENT STABILITY OF A SECTION OF THE MACHINE FOR BLACK FALLOW CULTIVATION IN A LONGITUDINAL-VERTICAL PLANE

/

СТІЙКІСТЬ РУХУ СЕКЦІЇ МАШИНИ ДЛЯ ОБРОБКИ ПАРІВ В ПОЗДОВЖНЬО-ВЕРТИКАЛЬНІЙ ПЛОЩИНІ

V. Bulgakov¹, S. Ivanovs², V. Nadykto³, V. Kaminskiy⁴, L. Shymko¹, H. Kaletnik⁵

¹National University of Life and Environmental Sciences of Ukraine,

²Latvia University of Life Sciences and Technologies, Latvia,

³Dmytro Motornyi Tavria State Agrotechnological University Ukraine,

⁴National Science Centre "Institute of Agriculture of NAAS", Ukraine,

⁵Vinnitsia National Agrarian University, Ukraine

*Correspondence: Tel.+37129403708, e-mail: semjons@apollo.lv

DOI: <https://doi.org/10.35633/inmateh-62-10>

Keywords: soil, black fallow, harrow, stability of movement

ABSTRACT

One of the tasks of using the black fallow in agricultural production is the weed control and the moisture conservation in the soil. Application of the most advanced soil cultivation technologies ensures preservation of no more than 75% of precipitations in the soil. To improve the state of this issue, we have developed a special machine for processing the black fallow. A mathematical model has been developed that describes the dynamics of the movement of the harrow section in a longitudinal-vertical plane, and its solution is given, which allows investigation of the impact of this or that design parameter upon the dynamics of the angle of rotation in time. The adequacy of the developed mathematical model is confirmed by special laboratory and field investigations of the created experimental machine. With rational design parameters the rotation angle of the harrow section in a longitudinal-vertical plane will not exceed – 3°, and the time of its exit to the equilibrium position will not exceed 16...17 s.

АНОТАЦІЯ

До основних завдань застосування парів в сільськогосподарському виробництві є боротьба з бур'янами та збереження ґрунтової вологи. Застосування найсучасніших технологій обробки ґрунту забезпечує збереження в ґрунті не більше 75% вологи. Для поліпшення стану у даному питанні нами розроблена спеціальна ґрунтообробна машина для обробки парів та проведено її дослідження. Розроблено математичну модель, що описує динаміку руху боронувальної секції в поздовжньо-вертикальній площині і приведено його розв'язування, яке дозволяє визначати вплив того чи іншого конструктивного параметра на динаміку зміни в часі кута її повороту. Адекватність розробленої математичної моделі підтверджено спеціальними лабораторно-польовими дослідженнями на створеній експериментальній установці. Встановлено, що при раціональних конструктивних параметрах значення кута повороту боронувальної секції в поздовжньо-вертикальній площині не перевищить – 3°, а час її виходу в рівноважний стан не перевищить 16...17 с.

INTRODUCTION

The main objectives of the use of the fallow in agricultural production are the weed control and the conservation (or even accumulation) of the soil moisture. Under arid farming conditions the second objective comes to the first place (Chang *et al.*, 1990). The lack of moisture in the sowing layer of the soil leads to a delay in sowing the crops. And this inevitably leads to a decrease in their productivity (Donaldson *et al.*, 2001).

But practice shows that even the application of modern soil cultivation technologies ensures the preservation in it of no more than three quarters of the precipitations falling over the entire period of the fallow treatment (Masse *et al.*, 1978). The remainder moisture, according to these and other researchers (Riar *et al.*, 2010), evaporates from the soil. In addition, they emphasise that the period of the soil retention in the state of the fallow lasts approximately 21 months. And, if at least 1/10 of the lost moisture could be additionally saved during this time, the yield of the cultivated crops could increase up to 25% (Adamchuk *et al.*, 2020).

There are several ways how to reduce the soil moisture loss when cultivating the black fallow. One of them is the use of such a soil cultivation system in which at least 30% left from the previous crop remain on its surface (Schillinger, 2001; Schillinger et al., 2006).

The second way is mechanical treatment of the fallow combined with chemical treatment of the weeds with herbicides (Smith and Young, 2000; Smith et al., 1996).

A fairly common method of reducing the moisture evaporation during the fallow processing is to create an upper mulching layer from the loosened soil (Al-Mulla et al., 2009; Massee et al., 1978; Schillinger and Papendick, 1997).

The unifying aspect of the above ways of reducing the soil moisture loss when processing the fallow is the tillage depth at a level of at least 10 cm (4 in.). And this is quite natural if we take into account the form and parameters of the working tools of the tillage machines to be used. As a rule, these are the disk harrows and heavy cultivators (Lindwall and Anderson, 1981), machines with V-shaped blades of working tools with the operating width of 75 cm or more (Schillinger and Papendick, 1997; Smith et al., 1996).

At the same time, already in 1909, the Russian scientist and practitioner I. Ovsinskiy convincingly proved that the depth of the mulching layer of the soil should not exceed two inches (2 in.), that is, it should be equal to 5...6 cm (Ovsinskiy, 2014). But, as established by our studies, it is in this layer that the most intensive evaporation of moisture from the treated soil occurs.

Hence it follows that, when processing the fallow field to a depth of 2 in., the degree of mixing of the soil, and especially bringing its moisture to the day surface of the field should be minimal. As practice shows, the above-mentioned working tools of the currently used tillage machines cannot satisfy such requirements. Even the use of single row disc tools or bar harrows (Schillinger and Papendick, 1997), in principle, capable of cultivating the soil to a depth of 2 in., does not solve the problem. First of all, because they (especially the disk harrows) mix the cultivated soil layer sufficiently intensively.

Based on the foregoing, we have developed a special machine for the treatment of the fallow, consisting of several harrow sections of a new design (Fig. 1).



Fig. 1 - The harrow section of a new design

Each of them has 20 working tools (5 rows of 4 tools in a row) mounted on a frame according to the law of a “zigzag” harrow.

The working tool of the section is a flat rod (tooth), 8 mm thick, with a flat blade, welded to it, with the operating width of 80 mm. The front row of the working tools of the section may be equipped with vertically mounted blades. By means of two links each section is attached to a beam, which, in turn, is connected to the aggregating tractor. One of the problematic issues of the operation of such a section is the stability of its movement in the longitudinal-vertical plane.

Properly selected design parameters of the section should provide a minimum deviation of its frame from the horizon. Besides, the duration of the transition of the section as a dynamic system from one steady state to another should be as small as possible. These are the problems the solution of which is the objective of the research, the results of which are presented in this article.

METHODS AND MATERIALS

First, we will consider theoretically the conditions for stable movement of the tillage (harrow) section in the longitudinal-vertical plane, for which we construct an equivalent scheme 2).

In the process of the working movement, caused by the action of force P , the deviation of the harrow section from a stable position can manifest itself in the form of its rotation angle by an angle β relative to the axis which is perpendicular to the longitudinal-vertical plane XOY and passes through point O .

Derivation of differential equations of such angular oscillations of the tillage section was carried out taking into account the following assumptions.

1. The gravity force of the harrow section G is concentrated at point C (see Fig. 2) which is located in the plane of the middle row of its teeth.
2. The traction resistance of the section is represented by the horizontal R_{xc} and vertical R_{yc} components applied in its “centre of resistance” (point D).
3. The rotation angle of the harrow section β is such that for it the following relations are true:
 $\sin \beta \approx \beta$; $\cos \beta \approx 1$.

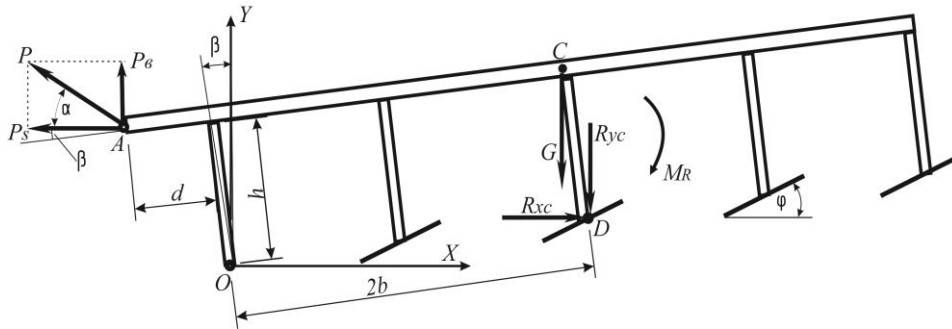

Fig. 2 - An equivalent scheme of forces acting upon the harrow section in a longitudinal-vertical plane

In its final form, the mathematical model describing the dynamics of the harrow section movement in a longitudinal-vertical plane has the form:

$$\ddot{\beta} + K_2 \cdot \dot{\beta} + K_1 \cdot \beta = K_o, \tag{1}$$

where $K_2 = 30 \cdot K_s \cdot b^2 \cdot J_o^{-1}$

$$K_1 = [P_s \cdot (d + 1.6b + \tan \alpha \cdot h) - G \cdot h] \cdot J_o^{-1}$$

$$K_o = -0.4b \cdot P_s \cdot \cot(\varphi + \varphi_o) \cdot J_o^{-1}$$

J_o – the inertia moment of the harrow section relative to the axis that is perpendicular to the XOY plane and passes through point O , [N·m·s²] (see Fig. 2);

K_s – the coefficient of resistance to the vertical movement of the working tools of the harrow section in the soil, [N·s·m⁻¹];

α – the inclination angle of the harrow, [deg.];

φ – the angle of installation of the harrow tooth segment to the horizon, [deg.];

φ_o – the angle of the soil friction along steel or the soil, [deg.];

b, d, h – the design parameters of the harrow section, as understood from Fig. 2.

The solution of equation (1) has the following form:

$$\beta = \frac{K_o}{K_1} + e^{\frac{1}{2}(-K_2 + \sqrt{K_2^2 - 4K_1})t} \cdot \frac{K_o \cdot (-K_2 - \sqrt{K_2^2 - 4K_1})}{2K_1 \cdot \sqrt{K_2^2 - 4K_1}} - e^{\frac{1}{2}(-K_2 - \sqrt{K_2^2 - 4K_1})t} \cdot 2 \cdot \frac{K_o \cdot (-K_2 + \sqrt{K_2^2 - 4K_1})}{2 \cdot K_1 \cdot \sqrt{K_2^2 - 4K_1}}. \tag{2}$$

Equation (2) allows investigation of the impact of one or another design parameter of the harrow section upon the dynamics of the time variation of its rotation angle β in a longitudinal-vertical plane. In addition, the vector (or direction) of mathematical simulation determines such a value of the corresponding structural

parameter that will provide the shortest possible time for the dynamic system (i.e., the harrow section) to reach stable equilibrium, provided that its rotation angle β is as small as possible.

To test the mathematical model (2) for adequacy, special laboratory and field experimental investigations were performed. As a physical object there was chosen an aggregate consisting of an electrified minitractor, aggregated with one harrow section (Fig. 3).



Fig. 3 - The harrow aggregate, composed on the basis of an electrical mini tractor

The harrow section of this aggregate was attached to a minitractor, using tensometric fingers. On the axis of one of them (3, Fig. 4), sensor 2 was installed in the form of a variable resistance SP-3A (Ukraine) with a linear characteristic and a nominal resistance of 470 Ohm. The rotor of this resistance was connected to leash 1, which was constantly in contact with the frame of the harrow section. The rotation of the latter in the longitudinal-vertical plane through leash 1 carried out the corresponding rotation of the resistance stator 2. The corresponding electrical signal, generated from sensor 2, was transmitted to an analogue-to-digital converter (ADC), which, together with the power supply and the computer, was mounted on the minitractor (Fig. 5).

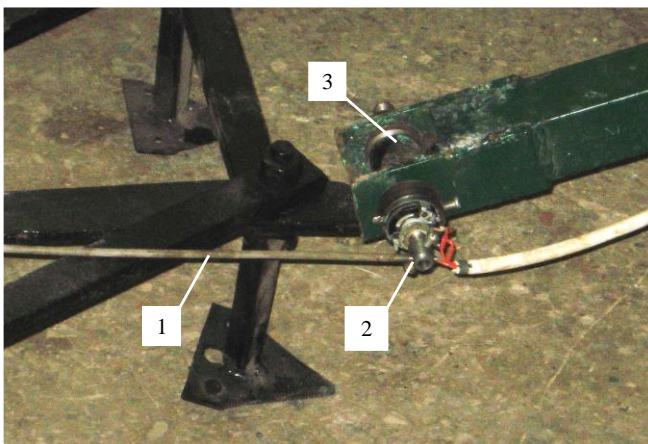

Fig. 4 - Installation of leash (1) and the angle sensor (2) of the harrow turn on its tensometric finger (3)



Fig. 5 - Installation of the ADC (1), the power supply (2) and the computer (3) on the tractor

The ADC digitalised data array in the form of the rotation angle of the harrow β entered the computer and was formed as an array, suitable for being processed by a graphical software environment (in this case, the Grapher 7 program).

The graphical dependence $\beta = f(t)$, constructed in this case, was compared with the calculated one, obtained in Mathcad 15.0 from equation (2).

Along with the signal from the SP-3A sensor, signals from the tensometric fingers of the harrow section were sent to the computer via the ADC (position 3, Fig. 4). These data were also generated in the form of digital arrays and were used to determine force P_s (Fig. 2).

To calculate equation (2), the following values of the parameters included in it were taken: $b = 0.15 - 0.45$ m ; $h = 0.08 - 0.14$ m ; $d = 0 - 0.20$ m ; $\alpha = 0 - 20^\circ$; $\varphi = 5^\circ$.

Considering the fact that the initial stage of using this tillage machine usually occurs when the soil moisture is 20...24%, the friction angle for it (φ_o) and the resistance coefficient of the vertical movement of the working tools in it (K_s) were assumed to be constant and equal to: $\varphi_o = 60^\circ$ $K_s = 5000 \text{ N} \cdot \text{s} \cdot \text{m}^{-1}$.

In order to determine the inertia moment of the harrow section in the longitudinal-vertical plane, it (the section) was regarded as a rectangle, the height of which was taken equal to the height of the tooth h .

The inertia moment of the section was calculated using the following expression:

$$J_o = \frac{G}{g \cdot 12} \cdot (52 \cdot b^2 + 12 \cdot h^2), \quad (3)$$

where $g = 9.81 \text{ m} \cdot \text{s}^{-2}$ – the acceleration of gravity; G – the force of weight of the harrow section, variable within 250...450 N.

The laboratory and field investigations of the aggregate took place in spring against an agrotechnical background, where the precursor was sunflower. After harvesting this crop, the stubble was twice (with an interval of two weeks) traversed with a disk harrow to the depth of 12...14 cm.

At the time of the laboratory and field experimental studies, in addition to the above parameters, the soil moisture and density in the layer of 0...10 cm, as well as the speed of the movement of this harrow aggregate, were measured.

To measure the soil moisture, an MG-44 electronic device (MirAgro, Ukraine) was used with a measurement accuracy of $\pm 0.1\%$.

The soil density was measured by means of an instrument the electronic scale of which allows immediate display of the value of the measured parameter in $\text{g} \cdot \text{cm}^3$.

The time (t_a) for the aggregate to pass the test section with a length of $L = 250 \text{ m}$ was recorded using an FS-8200 electronic stopwatch with a measurement accuracy of 0.1 s. The speed of the movement of this harrowing machine-and-tractor aggregate V_a was calculated according to the formula:

$$V_a = L \cdot (t_a)^{-1}. \quad (4)$$

All the measurements in the process of the laboratory and field research were performed in triplicate.

RESULTS AND DISCUSSION

The conditions for experimental laboratory and field investigations of the harrow aggregate are presented in Table 1.

Table 1

The conditions for experimental laboratory and field investigations of the harrow aggregate	
Indicator	Value
Type of the soil	Dark chestnut chernozem (black soil)
Relief	Flat
Microrelief	Levelled
Agricultural background	Disc-harrowed sunflower stubble
Soil humidity in a layer of 0...10 cm, %	21.5
Soil density in a layer of 0...10 cm, $\text{g} \cdot \text{cm}^{-3}$	1.14

As already emphasised above, in the process of checking the adequacy of a mathematical model of the plane-parallel movement of the harrow section, its traction resistance and the angle of rotation in a longitudinal-vertical plane were recorded. The investigated aggregate moved in the same gear in all experiments.

The analysis of the experimental data showed that the speed of the aggregate in all the experiments varied within the range of $2.00 \pm 0.01 \text{ m} \cdot \text{s}^{-1}$, the average traction resistance of the harrow section P_s being equal to 1500 N. It is this value of force P_s that was used in the calculation of equation (2).

The rotation angle of the harrow section varied in the confidence interval $\beta = -2.80 \pm 0.03 \text{ deg}$. The dispersion of the fluctuations of this angle was 0.0422 square degrees, and the coefficient of variation was 7.3%.

Comparison of the theoretical [calculated, using expression (2)] and theoretical processes of changing the angle of rotation of the harrow section in a longitudinal-vertical plane in time showed that the maximum difference between the analytical and the field data is not constant (Fig. 6).

Within the transient process of the movement of the considered dynamic system ($t=0\ldots 0.7$ s) this difference may reach 40% (for $t=0.2$ s, for example). At the same time, outside this rather short-term range ($t>0.7$ s, Fig. 6), the difference between the calculated and the experimental data does not exceed 20%. Besides, it should be borne in mind that the condition of a steady-state movement of the harrow section, in contrast to the short-term transitional one, is decisive. With this in mind, the indicated difference (<20%) between the field data and the results of mathematical simulation points to the adequacy of the developed mathematical model of plane-parallel movement of the harrow section. And this gives the right to use it (i.e., the model) for further mathematical simulation in order to justify reliable design parameters of the developed tillage machine.

The results of such modelling show that the fluctuations of the angle of rotation of the harrow section in the longitudinal-vertical plane relative to point O (see Fig. 2) are of an aperiodic nature (Fig. 7).

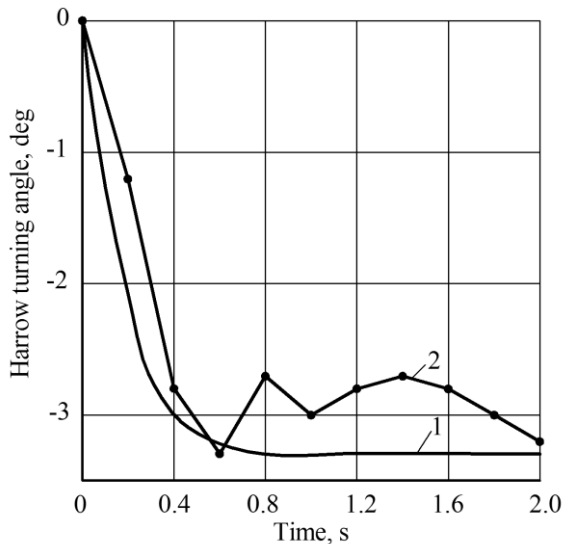

Fig. 6 - Theoretical (1) and experimental (2) dynamics of angle β changes in time

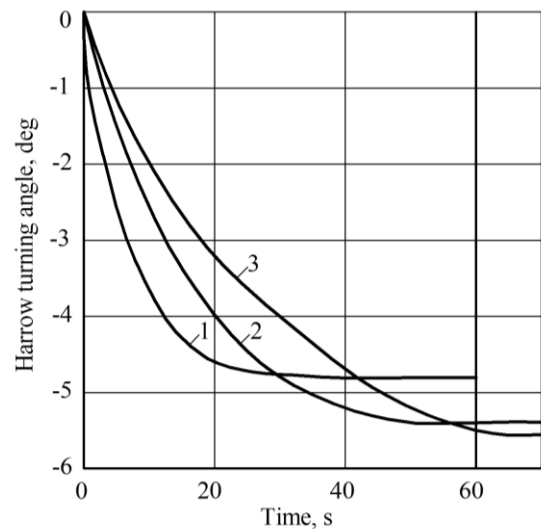

Fig. 7 - Dynamics of changes in the angle of rotation of the harrow section at different distances between the rows of its teeth: 1 – $b = 0.15$ m; 2 – $b = 0.30$ m; 3 – $b = 0.45$ m

In the process of the movement the harrow makes angular clockwise deviations. From Fig. 2 it follows that such a direction of its rotation is negative, which is reflected by the corresponding sign of the parameter β .

Analysis of the data, presented in Fig. 7, shows that the larger the longitudinal distance between the rows of the teeth of the harrow section (parameter b), the longer the time it takes for it to reach the steady-state position. So, if at a value $b = 0.15$ m the steady-state movement of the harrow occurs after 20 s (Curve 1, Fig. 7), then at $b = 0.45$ m this state of the dynamic system takes place not earlier than 65 s (Curve 3).

Moreover, if in the first case the harrow deviates by an angle of -4.8° , then in the second case this indicator increases to -5.8° . Although the difference between the values of angle β is only 1° , the tendency of the behaviour of the considered dynamic system changes. In this case it is the following: the smaller the value of the parameter b , the smaller the amplitude of the deviation of the tillage section from the horizontal position, and the shorter the time period for it to reach the condition of equilibrium.

The opposite (in the quality terms) impact upon the angle of rotation of the harrow section in the longitudinal-vertical plane is made by the coordinate of the offset of its leashes' attachment point. So, when establishing them with the offset $d = 0$ (see Fig. 2), the steady movement of the harrow occurs only after 70 s, and it is characterised by a negative slope (rotation) of the tillage section by angle $\beta = -6.5^\circ$ (Curve 1, Fig. 8).

Increasing the value of parameter d to 0.10 m, the steady-state movement of the harrow section starts approximately at the same time (that is, 70 s), yet the angle of its deviation decreases to -5.7° (Curve 2, Fig. 8).

At the same time, increasing the offset of the attachment point of the harrow section leashes to $d = 0.20$ m, the transition time to its steady movement starts after 38 s, i.e., it increases practically two times (compared with the previous two versions). The deviation angle of the harrow from its horizontal position also decreases, and it is -4.6° (Curve 3, Fig. 8). It is clear that this is a positive factor.

In contrast to the structural parameters, analysed above, the inclination angle of the harrow section leashes α has little impact upon its rotation dynamics in the longitudinal-vertical plane. Changing this parameter from 0 to 20° helps reducing angle α by only 0.5° (Fig. 9).

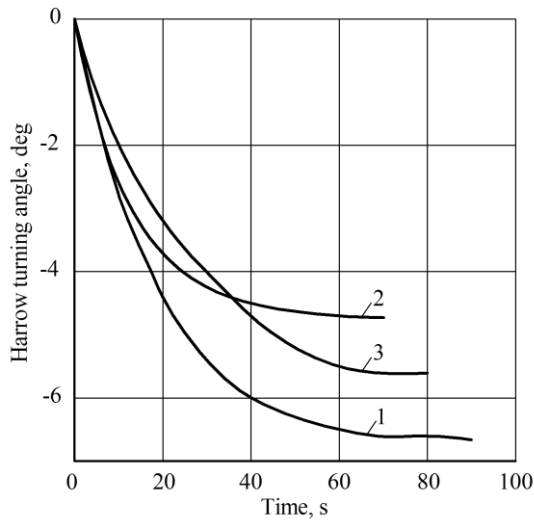

Fig. 8 - Dynamics of the angle of rotation of the harrow section with different offsets of its leashes' attachment point: 1 – $d = 0$; 2 – $d = 0.10$ m; 3 – $d = 0.20$ m

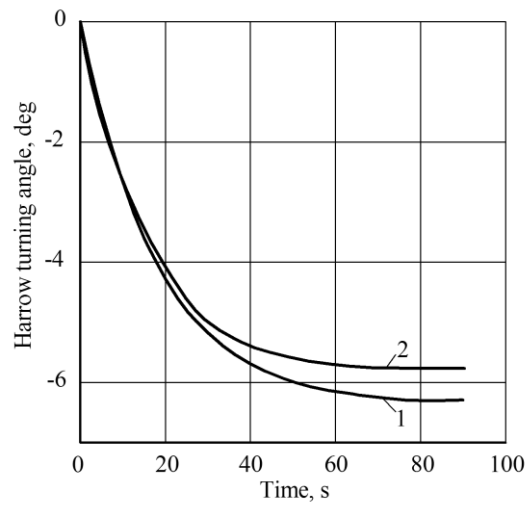

Fig. 9 - Dynamics of changes in the angle of rotation of the harrow section at different inclination angles of its leashes: 1 – $\alpha = 0$; 2 – $\alpha = 20^\circ$

An even smaller impact upon the angle of deviation of the harrow section from the horizontal position is exerted by its force of gravity G and the height of the teeth h . When changing these design parameters within the above ranges, the angle of rotation of the harrow β changes within the range $0.15...0.20^\circ$.

The analysis of the above material allows choosing such values of the structural parameters which cause a decrease in the angle of deviation of the harrow from the horizontal position and the time it takes to reach a new equilibrium state. Thus, the calculations show that at $P_s = 1500$ N , $G = 300$ N , $\varphi = 5^\circ$, $\varphi_o = 60^\circ$, $\alpha = 25^\circ$, $h = 0.14$ m , $b = 0.15$ m and $d = 0.25$ m, the value of the rotation angle of the harrow section in the longitudinal-vertical plane β will not exceed -3° (Fig. 10).

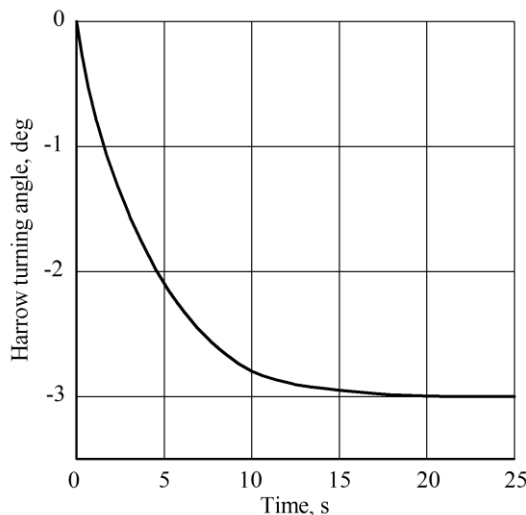

Fig. 10 - Dynamics of the angle of rotation of the harrow section with rational values of its design parameters

The exit of the section from the transition mode to the mode of a new equilibrium state does not exceed 16...17 s, and it is of a purely aperiodic nature.

CONCLUSIONS

1. The smaller is the distance between the rows of teeth of the harrow section b , the smaller is the amplitude of its deviation from the horizontal position, and the less time it takes to reach the steady-state position. It has been established by calculations that reducing parameter b three times (from 0.15 to 0.45 m) with a smaller angle of rotation of the tillage section, the time period for its entry into equilibrium decreases from 65 to 20 s (i.e., 3.25 times).

2. Increasing the offset coordinate of the attachment point of the harrow section leashes from 0 to 0.2 m, the angle of its deviation from the horizontal position and the time to reach the new equilibrium position decreases by almost half, which is the desired result.

3. At the values of parameters $P_s = 1500 \text{ N}$, $G = 300 \text{ N}$, $\varphi = 5^\circ$, $\varphi_o = 60^\circ$, $\alpha = 25^\circ$, $h = 0.14 \text{ m}$, $b = 0.15 \text{ m}$ and $d = 0.25 \text{ m}$, the value of the rotation angle of the harrow section in the longitudinal-vertical plane will not exceed -3° , and the time of its entry into the equilibrium position will not exceed 16...17 s.

REFERENCES

- [1] Adamchuk, V., Bulgakov, V., Nadykto, V., Ivanovs, S. (2020). Investigation of tillage depth of black fallow impact upon moisture evaporation intensity. *Engineering for rural development*, Vol. 19: pp. 377-383.
- [2] Al-Mulla, Y.A., Wu, J.Q., Singh, P., Flury, M., Schillinger, W.F., Huggins, D.R., Stöckel, C.O. (2009). Soil water and temperature in chemical versus reduced-tillage fallow in a Mediterranean climate. *Appl. Eng. Agric.*, 25: pp. 45–54.
- [3] Chang, C., Sommerfeldt, T.G., Entz, T., Stalker, D.R. (1990). Long-term soil moisture status in Southern Alberta. *Can. J. Soil Sci.*, 70: pp.125–136.
- [4] Donaldson, E., Schillinger, W.F., Dofing, S.M. (2001). Straw Production and Grain Yield Relationships in Winter Wheat. *Crop Sci.*, 41: pp.100–106.
- [5] Lindwall, C.W., Anderson, D.T. (1981). Agronomic evaluation of minimum tillage systems for summer fallow in Southern Alberta. *Can. J. plant Sci.*, 61: pp.247–253.
- [6] Masee, T.W., Cary, J.W., Plains, G., Desert, A. (1978). Potential for reducing evaporation during summer fallow. *J. Soil Water Conserv.*, 33: pp.126–129.
- [7] Moreno, M.M., Lacasta, C., Meco, R., Moreno, C. (2011). Rainfed crop energy balance of different farming systems and crop rotations in a semi-arid environment: Results of a long-term trial. *Soil Tillage Res.*, 114: pp.18–27. <https://doi.org/10.1016/j.still.2011.03.006>
- [8] Nadykto, V., Kotov, O. (2015). *Method for determining soil bulk density (in Ukrainian: Sposib viznachennya shchilnosti gruntu)*. UA 97828, G 01N 1/00.
- [9] Ovsinskiy, I. (2014). *New Farming System*. Moscow (in Russian).
- [10] Riar, D.S., Ball, D.A., Yenish, J.P., Wuest, S.B., Corp, M.K. (2010). Comparison of fallow tillage methods in the intermediate rainfall inland Pacific Northwest. *Agron. J.*, 102: pp.1664–1673. <https://doi.org/10.2134/agronj2010.0054>.
- [11] Schillinger, W.F. (2001). Minimum and Delayed Conservation Tillage for Wheat-Fallow Farming. *Soil Sci. Soc. Am. J.*, 65: pp.1203–1209. <https://doi.org/10.2136/sssaj2001.6541203x>
- [12] Schillinger, W.F., Papendick, R.I. (1997). Tillage Mulch Depth Effects during Fallow on Wheat Production and Wind Erosion Control Factors. *Soil Sci. Soc. Am. J.*, 61: pp.871–876.
- [13] Schillinger, W.F., Papendick, R.I., Guy, S.O., Rasmussen, P.E., Van Kessel, C. (2006). *Dryland Cropping in the Western United States. Dryland Agriculture*. 2nd Ed., Agronomy Monograph, 23. ASA, CSSA, and SSSA, Madison, WI: pp. 365–393.
- [14] Smith, E.C., Young, D.L. (2000). Requiem for summer fallow. *Choices*: pp. 24–25.
- [15] Smith, E.G., Peters, T.L., Blackshaw, R.E., Lindwall, C.W., Larney, F.J. (1996). Economics of reduced tillage fallow-crop systems in the dark brown soil zone of Alberta. *Can. J. soil Sci.*, 76: pp.411–416. <https://doi.org/10.4141/cjss96-049>
- [16] Zhuk, A.F. (2013). Work Wedge with Soil Growths. *Mech. Electr. Agric.*, 97: pp.148-161 (in Russian).