



№ 1(63), 2021

MACHINE BUILDING. PROCESS METALLURGY. MATERIALS SCIENCE

Koshel G. , Koshel S. Issue: 2021, №1(63)
ANALYSIS OF THE REVERSING MECHANISM OF LIGHT INDUSTRY EQUIPMENT 

Sydorenko I.I. , Prokopovich I.V. , Zhang Y. , ... Issue: 2021, №1(63)
SIMULATION OF A FLOATING BOLLARD OF A SHIP LOCK BY THE FINITE ELEMENT METHOD 

Babka V. , Pylypaka S. , Volina T. Issue: 2021, №1(63)
THE MOTION OF A PARTICLE ON A WAVY SURFACE DURING ITS TRANSLATIONAL CIRCULAR OSCILLATIONS IN HORIZONTAL PLANES 

Petrov L. , Borisenko T. , Kishianus I. , ... Issue: 2021, №1(63)
THEORETICAL ELEMENTS OF ENERGY MODULAR LAYOUT OF AUTOMOBILE SYSTEM 

Petrik Y. , Petrov L. Issue: 2021, №1(63)
THEORETICAL RESEARCHES OF A CAR WHEEL WITH A TRACTION COMPENSATOR 

ENERGETICS. HEAT ENGINEERING. ELECTRICAL ENGINEERING

Wysochin V.V. , Nikulshin V.R. , Denysova A.E. Issue: 2021, №1(63)
FACTORS OF THE PVT-COLLECTOR EFFICIENCY FORMATION 

Hraniak V. Issue: 2021, №1(63)
METHOD AND MEANS FOR MEASURING THE TEMPERATURE OF THE POLE WINDINGS OF THE ELECTRIC MACHINE ROTOR 

Kravchenko V.P. , Xiaolong Z. Issue: 2021, №1(63)
METHOD AND RESULTS OF HYDRAULIC CALCULATION OF THE HEAT EXCHANGE SURFACE OF THE ONCE-THROUGH STEAM GENERATOR 

CHEMISTRY. CHEMICAL ENGINEERING

Tigarev V.M. , Barchanova Y.S. , Prokopovich I.V. , ... Issue: 2021, №1(63)
AN INDIVIDUAL MASK CREATION USING THE INFORMATION MODEL 

Manicheva N. , Dudzinskii J. , Titova N. , ... Issue: 2021, №1(63)
DETERMINATION OF THE NONLINEAR PARAMETER AND INTERNAL PRESSURE IN A LIQUID BY THE ACOUSTIC METHOD 

UDC 536.521

V. Hraniak, PhD, Assoc. Prof.

Vinnytsia National Agrarian University, 3 Sonyachna Str., Vinnytsia, Ukraine, 21008; e-mail: titanxp2000@ukr.net

METHOD AND MEANS FOR MEASURING THE TEMPERATURE OF THE POLE WINDINGS OF THE ELECTRIC MACHINE ROTOR

В.Ф. Граняк. Метод та засіб вимірювання температури полюсних обмоток ротора електричної машини. Температура полюсних обмоток є одним із основних інформативних параметрів, відхилення якого може свідчити про наявність ряду поширених дефектів електричних машин. Про те реалізація високоточних засобів вимірювання температури полюсних обмоток ротора електричної машини пов'язана з рядом технічних труднощів. Мета – підвищення точності вимірювання температури полюсних обмоток ротора електричної машини шляхом розробки безконтактного методу та засобу вимірювання температури полюсних обмоток ротора в режимі реального часу. В роботі показано, що існуючі найбільш поширені методи вимірювання температури мають суттєві недоліки, які обмежують можливість їх застосування для реалізації засобів вимірювання полюсних обмоток ротора електричної машини. Запропоновано біспектральний пірометричний метод вимірювання температури, який передбачає одночасне перетворення у напругу функціонально залежних від температури спектральних густин випромінювання для двох спектрально близьких електромагнітної хвиль з подальшим знаходженням їх відношення, що дозволило вилучити найбільш істотні складові методичної похибки, характерної для класичного пірометричного методу вимірювання. Розроблено конструкцію реалізованої на основі запропонованого методу вимірювання біспектральної пірометричної вимірювальної система температури полюсних обмоток ротора обертових електричних машин, придатної для роботи у режимі реального часу сумісно з системами контролю технічного стану та діагностування.

Ключові слова: вимірювання, температура, електрична машина, полюсна обмотка ротора, теплове випромінювання

V. Hraniak. Method and means for measuring the temperature of the pole windings of the electric machine rotor. The temperature of the pole windings is one of the main informative parameters, the deviation of which may indicate the presence of a number of common defects of electrical machines. However, the implementation of high-precision means for measuring the temperature of the pole windings of the electric machine rotor is associated with a number of technical difficulties. The aim is to increase the accuracy of measuring the temperature of the pole windings of the rotor of an electric machine by developing a contactless method and means of measuring the temperature of the pole windings of the rotor in real time. The paper shows that the existing most common methods of temperature measurement have significant disadvantages that limit the possibility of their use for the implementation of means of measuring the pole windings of the rotor of an electric machine. A bispectral pyrometric method of temperature measurement is proposed, which provides simultaneous conversion into voltage of functionally temperature-dependent spectral densities of radiation for two spectrally close electromagnetic waves with subsequent finding of their ratio, which allowed to remove the most significant components of methodical measurement characteristic of classical pyrometers. The design of the bispectral pyrometric measuring system of temperature of pole windings of a rotor of rotating electric machines realized on the basis of the offered method of measurement, suitable for work in a real-time mode together with systems of control of a technical condition and diagnostics is developed.

Keywords: measurement, temperature, electric machine, rotor pole winding, thermal radiatio

Introduction

Monitoring the technical condition of rotating electric machines in the process mode is a promising area to increase reliability and reduce operating costs associated with both scheduled repairs and technological downtime due to the withdrawal of the latter during the repair process. Among the most common defects of electric machines, the lion's share are defects, the presence of which can be detected during the operational control of the temperature of the pole windings [1]. In particular, the results of statistical analysis of the distribution of defects that occur during the operation of synchronous motors, make it possible to distinguish the following the most probable types of defects of this type of equipment [2]:

- mechanical damage to the insulation of the pole windings of the rotor – 30 %;
- electrical breakdown of interturn insulation – 15 %;
- damage to bearings – 12 %;
- mechanical damage to the insulation of the stator windings – 11 %;

DOI: 10.15276/opus.1.63.2021.08

© 2021 The Authors. This is an open access article under the CC BY license (<http://creativecommons.org/licenses/by/4.0/>).

- mechanical deformation of rotor or stator structures – 9 %;
- operation of the electric motor on two phases – 8 %;
- breakage or weakening of the rotor winding mounting – 6 %;
- weakening of fastening of stator windings – 3 %;
- motor rotor imbalance – 3 %;
- non-alignment of shafts – 2 %;
- other defects – 1 %.

It is obvious that in the presence of such defects as mechanical damage to the insulation of the pole windings of the rotor, electrical breakdown of the interturn insulation, mechanical damage to the insulation of the stator windings and two-phase motor operation, the temperature of individual windings of the electric machine will deviate from normal. Defects such as mechanical damage to the insulation of the pole windings of the rotor and electrical breakdown of their interturn insulation (more than a third of the total number of cases) will be accompanied by abnormal overheating of the pole windings of the rotor. It is also obvious that defects associated with damage to the insulation of the rotor windings will occur during the operation of other types of electric machines (DC electric machines, induction motors with a phase rotor, etc.).

It should be noted that these defects will be characterized by an increase in temperature of both the defective and undamaged part of the pole winding, as a consequence of a sufficiently high thermal conductivity of the latter. Since temperature is one of the main parameters that determine the chemical and physical properties of the substance [3, 4], including the dielectric properties of insulation, long-term operation of an electric machine in the presence of relevant defects will lead to rapid wear of intact insulation. And when the critical temperature is reached, such operation can lead to the launch of an avalanche effect, which will result in almost instantaneous destruction of most structural elements of the electric machine.

Therefore, given the above, it is obvious that the development of high-precision methods and means of measuring the temperature of the pole windings of the rotor of rotating electric machines, suitable for real-time operation, which can be used to build highly efficient systems for monitoring and diagnosing rotating electric machines scientific and applied task, which has significant practical value.

Analysis of existing methods of temperature measurement

The choice of the optimal method of temperature measurement is determined, first of all, by the required measurement range, allowable accuracy and speed [5]. Typical approaches to automated temperature measurement in the average range of values, which corresponds to the typical operating conditions of the windings of rotating electric machines (from 40 °C to 180 °C) [6], are the use of contact measurement methods that involve the use of resistance thermometers as primary measuring transducers. or thermocouples. However, when measuring the temperature of the polar windings of the rotor, the use of contact sensors has significant limitations associated with the need to add extra weight to the rotating part of the electric machine, which will inevitably lead to its unbalance. In addition, the placement of contact sensors on the rotor windings is associated with technical difficulties in establishing communication between the latter, which will be on the moving part of the electric machine, with the measuring system [5, 7], which in combination with the above limitation makes these methods insufficient effective for implementing a means of measuring the temperature of the polar windings of the rotor.

A separate promising non-contact method designed to measure temperature in the middle range of values is the method of measurement based on the effect of temperature attenuation of the phosphor, described in [7]. The measuring instruments based on it, although characterized by high sensitivity, have a narrow measuring range, which corresponds to the linear section of the temperature attenuation of the luminescent material (the width of the measuring range for different phosphors is in the range of 50...70 °C), characterized by a rather complex design and low energy efficiency, as they require an additional source of excitatory radiation. An additional disadvantage that limits the widespread use of this method is that it involves the application of a special fluorescent coating on the ob-

ject of measurement, which is characterized by a fairly rapid aging [7]. Therefore, given the above, we can conclude that it is limited to apply it to solve the problem.

The classical pyrometric method of temperature measurement, based on the analysis of the intensity of its own thermal radiation of the object of measurement is mainly adapted for the measurement of high temperatures (up to 3000 °C and above) [5, 8]. The limitation of the application of this method in the average range of temperature change is due to the low energies of thermal radiation from the object of measurement. This leads to a significant component of the error due to the influence of external non-informative factors and different radiation coefficients of materials [9], the presence of which will significantly impair the accuracy of the measuring instrument.

Therefore, it is obvious that the task of implementing a high-precision means of measuring the temperature of the pole windings of the rotor of an electric machine will require the development of a new or further development of an existing measurement method, which would be characterized by non-contact and increased accuracy in the above range. Therefore, it can be concluded that the development of a high-precision instrument for measuring the temperature of the pole windings of the rotor, suitable for operation in conjunction with technical monitoring and diagnostic systems, will involve two scientific and applied problems. This is the development of a high-precision non-contact method of temperature measurement and the development of a high-precision measuring instrument based on it.

The aim of the work is to develop a non-contact method and means of measuring the temperature of the pole windings of the rotor of an electric machine, suitable for operation in conjunction with technical condition monitoring and diagnostic systems.

Development of non-contact methods of temperature measurement

As shown above, the most informative parameter related to temperature and which can be analyzed in the absence of direct contact between the sensor and the object of measurement is thermal radiation. The spectral density of radiation for an absolutely black body can be calculated on the basis of Planck's law of radiation [10]:

$$b(\lambda, T) = \frac{2hc^2}{\lambda^5} \cdot \frac{1}{e^{\frac{hc}{k\lambda T}} - 1}, \quad (1)$$

where h – Planck's Constant; c – speed of light propagation in vacuum; k – is the Boltzman constant; λ – is the length of the analyzed electromagnetic wave; T – absolute temperature.

According to Van's law of displacement, the length of the electromagnetic wave at which the maximum of thermal radiation is observed can be determined from the relation [11]:

$$\lambda_{\max} = \frac{0.002898}{T}.$$

Since the maximum radiation for objects with a temperature in the studied range of values falls on the infrared region of the spectrum [10], for which the relation:

$$hc \gg k\lambda T,$$

then the dependence (1) taking into account the simplification of the law of Wine radiation [10] with a sufficiently high accuracy can:

$$b(\lambda, T) = \frac{2hc^2}{\lambda^5} \cdot e^{-\frac{hc}{k\lambda T}}.$$

In this case, for a real object of measurement, which is not a completely black body, the spectral density of radiation will be determined:

$$b_p(\lambda, T) = b(\lambda, T) \cdot \varepsilon(\lambda, T), \quad (2)$$

where $\varepsilon(\lambda, T)$ – the coefficient of emissivity of the measurement object.

Given that the analyzed electromagnetic wave on the way from the measurement object to the photodetector must overcome the air environment and the optical system located at the inlet of the

photodetector, and provided that the inlet of the latter is close to the ideal circle, the voltage at the photodetector output taking into account (2) can be found as [11]:

$$u(\lambda, T) = \frac{\pi D_0^2 k_b^2}{16} \cdot S \cdot \varepsilon(\lambda, T) \cdot \tau_c(\lambda) \cdot b(\lambda, T) \cdot \tau_o(\lambda), \quad (3)$$

where $\tau_c(\lambda)$ – air permeability coefficient; $\tau_o(\lambda)$ – coefficient of transmittance of the optical system; k_b – sighting coefficient; D_0 – the diameter of the inlet of the optical system; S – sensitivity of the photodetector.

Analyzing the dependence (3), it is not difficult to conclude that in the implementation of pyrometric measuring instruments, the most significant component of the methodological error will arise due to the coefficient of emissivity of the object of measurement $\varepsilon(\lambda, T)$. It will significantly depend on the physical properties of its surface, its condition, the degree of contamination and so on. This feature can lead to a significant difference in the value of the latter for different pole windings of the rotor of one electric machine and its variability over time. Additional sources of methodological error will be the transmittance of the air environment $\tau_c(\lambda)$ and the transmittance of the optical system $\tau_o(\lambda)$, which also largely depend on environmental factors.

To remove this methodological component of the error, it is proposed to simultaneously convert into voltage the temperature-dependent spectral densities of radiation of two narrowband electromagnetic waves. In this case, the voltage at the outputs of the first $u_1(\lambda_1, T)$ and the second $u_2(\lambda_2, T)$ optical channels, taking into account the above mathematical apparatus, can be defined as:

$$\begin{cases} u_1(\lambda_1, T) = \frac{\pi D_0^2 k_b^2}{16} \cdot S \cdot \varepsilon(\lambda_1, T) \cdot \tau_c(\lambda_1) \cdot b(\lambda_1, T) \cdot \tau_o(\lambda_1), \\ u_2(\lambda_2, T) = \frac{\pi D_0^2 k_b^2}{16} \cdot S \cdot \varepsilon(\lambda_2, T) \cdot \tau_c(\lambda_2) \cdot b(\lambda_2, T) \cdot \tau_o(\lambda_2). \end{cases}$$

In this case, if as the intermediate measuring value to use the ratio of voltages at the outputs of the first $u_1(\lambda_1, T)$ and the second $u_2(\lambda_2, T)$ optical channels $K(T)$, then under the condition of spectral proximity λ_1 and λ_2 the emissivity of the winding surface, the specified coefficient for both waves can be considered constant. In this case, ensuring the maximum identity of the transmittance of the optical systems of both optical channels and taking into account the fact that both electromagnetic waves will propagate through the same air, the resulting parameter $K(T)$ can be defined as:

$$K(T) = \frac{u_1(\lambda_1, T)}{u_2(\lambda_2, T)} = \frac{\lambda_2^5}{\lambda_1^5} \cdot e^{-\frac{hc}{k\lambda_{ek}T}}, \quad (4)$$

where λ_{ek} – equivalent electromagnetic wavelength, which can be calculated as:

$$\lambda_{ek} = \frac{\lambda_1 \cdot \lambda_2}{\lambda_2 - \lambda_1}.$$

As follows from (4), the resulting parameter $K(T)$ will be free from a significant component of the methodological error characteristic of the classical pyrometric method of measurement while maintaining its inherent contactlessness and high speed. Based on the above, a bi-spectral pyrometric method of measurement can be formulated, the implementation algorithm of which is shown in the block diagram (Fig. 1).

To establish the type of static characteristics of the measuring instrument that implements the proposed method, we model (4) at the lengths of the studied electromagnetic waves $\lambda_1 = 10 \mu\text{m}$ and $\lambda_2 = 8 \mu\text{m}$.

To determine the degree of nonlinearity of the static characteristic shown in Fig. 2, calculate the relative error of nonlinearity:

$$\delta_{nl}(T) = \left| \frac{K(T) - K_l(T)}{K(T)} \right| \cdot 100, \quad (5)$$

where $K_l(T)$ – linearized dependence of the resulting parameter on temperature.

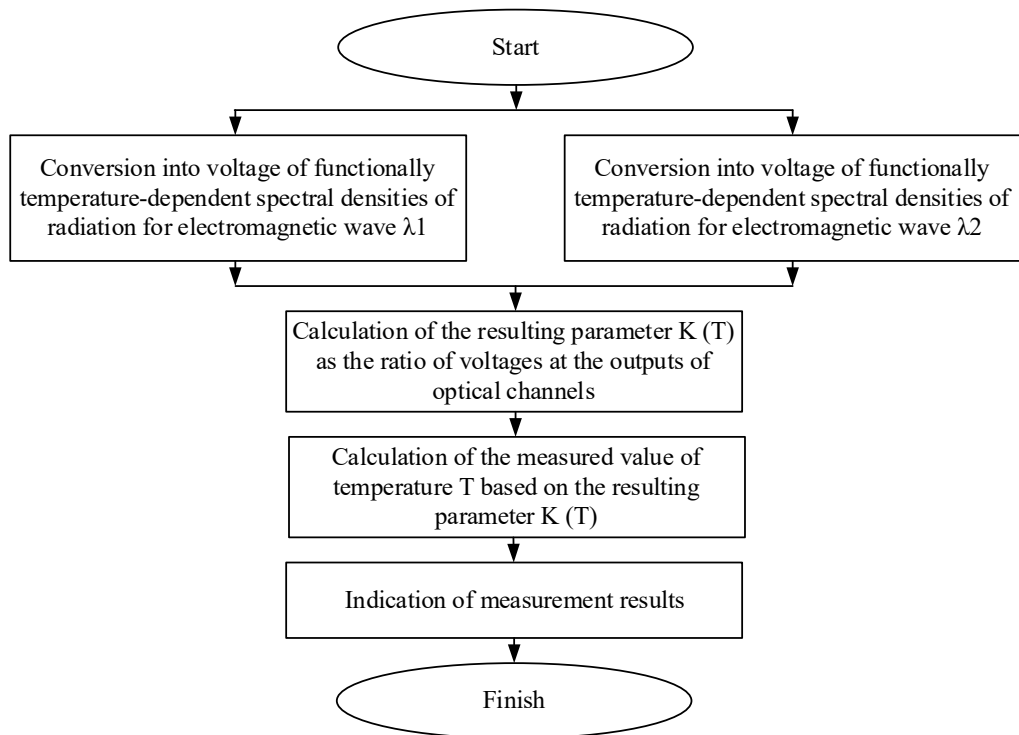

Fig. 1. Generalized block diagram of the algorithm for implementing bispectral pyrometric method of temperature measurement

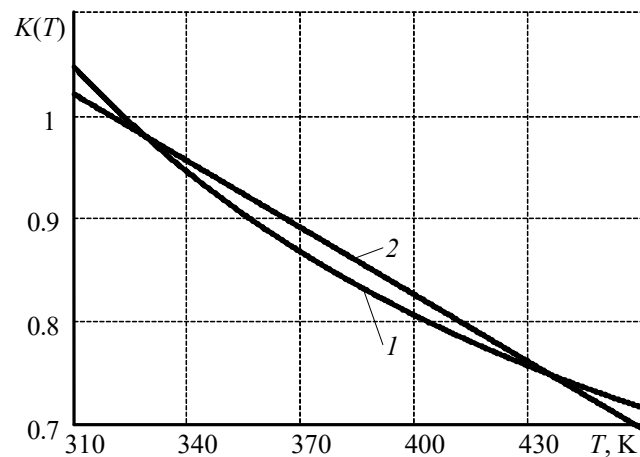

Fig. 2. Static characteristics of the measuring instrument that implements the bispectral pyrometric method of temperature measurement at the lengths of the studied electromagnetic waves $\lambda_1 = 10 \mu\text{m}$ and $\lambda_2 = 8 \mu\text{m}$:
1 – real characteristic; 2 – linearized static characteristic

The simulation results (5) are shown in Fig. 3.

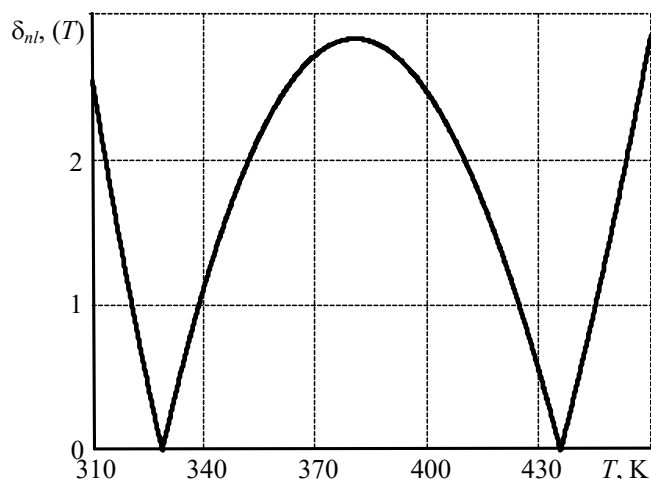

Fig. 3. Dependence of nonlinearity error on the measured temperature value at the studied electromagnetic wavelengths $\lambda_1 = 10 \mu\text{m}$ and $\lambda_2 = 8 \mu\text{m}$

As follows from the analysis of the dependences shown in Fig. 2 and Fig. 3, for given lengths λ_1 and λ_2 , the static characteristic of the measuring instrument that implements the bispectral pyrometric method of temperature measurement will be characterized by pronounced nonlinearity.

In particular, for the stated measurement range, when linearizing the static characteristic, a nonlinearity error will be introduced, the maximum value of which will approach 3 %. This measuring instrument will be characterized by a relatively high negative sensitivity (from $-3.923 \cdot 10^{-3} \text{ K}^{-1}$ to $-1.22 \cdot 10^{-3} \text{ K}^{-1}$).

To establish the nature of the change in the shape of the static characteristic from the absolute difference in the lengths of the studied electromagnetic waves, we model (4) and (5) at $\lambda_1 = 10 \mu\text{m}$ and $\lambda_2 = 6 \mu\text{m}$. The simulation results are shown in Fig. 4 and Fig. 5.

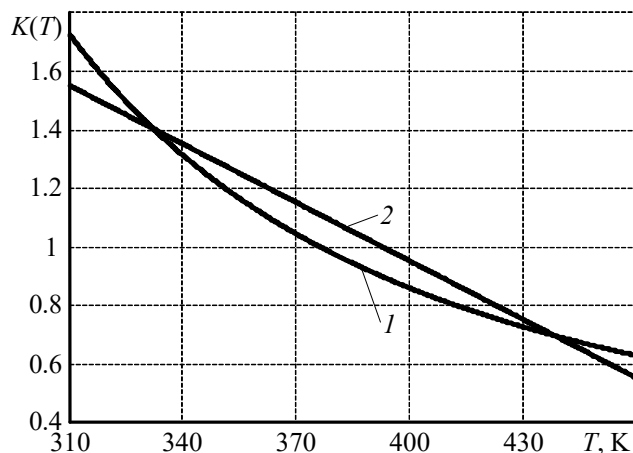

Fig. 4. Static characteristics of the measuring instrument that implements the bispectral pyrometric method of temperature measurement at the lengths of the studied electromagnetic waves $\lambda_1 = 10 \mu\text{m}$ and $\lambda_2 = 6 \mu\text{m}$:
 1 – real characteristic; 2 – linearized static characteristic

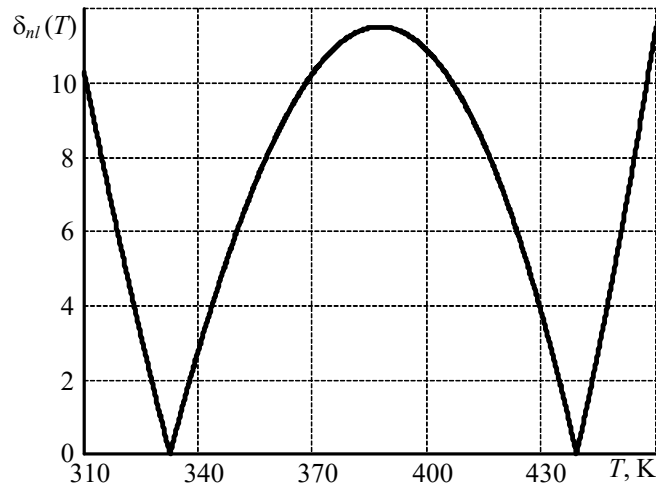

Fig. 5. Dependence of nonlinearity error on the measured temperature value at the studied electromagnetic wavelengths $\lambda_1 = 10 \mu\text{m}$ and $\lambda_2 = 6 \mu\text{m}$

As follows from Fig. 4 and Fig. 5, with increasing difference in the lengths of the studied electromagnetic waves λ_1 and λ_2 , there is an increase in the modulus of sensitivity while maintaining the nature of its dependence on temperature.

In particular, for the stated measurement range and the lengths of the studied electromagnetic waves $\lambda_1 = 10 \mu\text{m}$ and $\lambda_2 = 6 \mu\text{m}$, the sensitivity of the measuring instrument will be in the range from $-17 \cdot 10^{-3} \text{ K}^{-1}$ to $-2.846 \cdot 10^{-3} \text{ K}^{-1}$. However, with increasing difference in the lengths of the studied electromagnetic waves, there is a sharp increase in the nonlinearity of the static characteristic. For the declared measurement range and the selected lengths of the studied electromagnetic waves, the nonlinearity error will approach 12 %.

Development of a means of measuring the temperature of the pole windings of the rotor of an electric machine

Based on the proposed bispectral pyrometric method of temperature measurement, a bispectral pyrometric temperature measurement system for the polar windings of the rotor of rotating electric machines was developed, the block diagram of which is shown in Fig. 6.

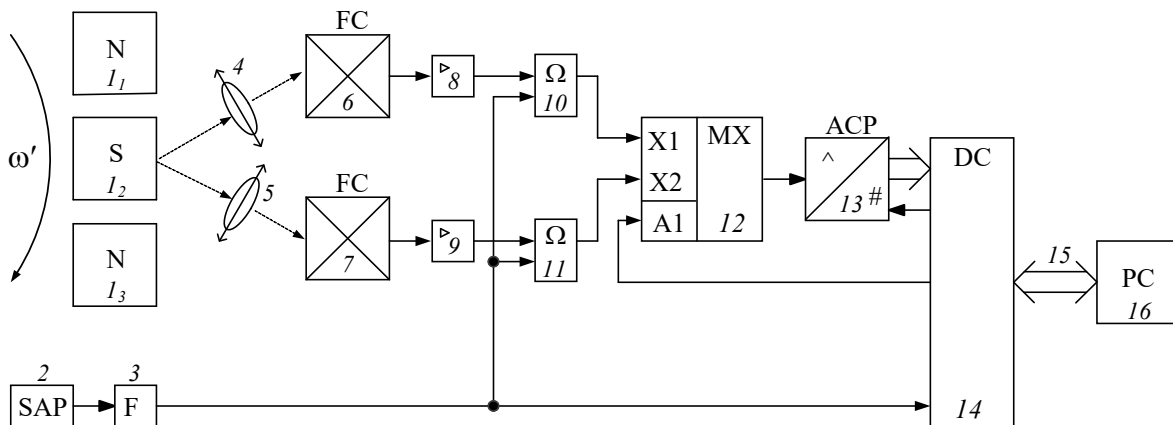

Fig. 6. Block diagram of the bispectral pyrometric measuring system of temperature of the pole windings of the rotor of rotating electric machines

Listed in Fig. 6 bispectral pyrometric measuring system of temperature of pole windings of a rotor of rotating electric cars works as follows.

When rotating the rotor of the electric machine at a certain angle, which corresponds to the location of the pole winding I_i , opposite the first 4 and the second 5 of the filtering lens, the sensor of the angular position 2 generates a pulse coming to the input of the shaper 3. The duration of the generated pulse will be different for the zero position (placed opposite the first 4 and second 5 filtering condenser lenses of the first pole winding I_1) and other fixed angular positions. In the shaper 3, the pulse signal from the sensor of the angular position 2 is reduced to a single logic level with steep edges. A single logic signal from the output of the shaper 3 is fed to the second inputs of the first 10 and second 11 blocks of analog memory and the second input of the numerical converter 14. Different pulse durations for the first I_1 and other $I_2 - I_n$ pole windings of the electric machine provide the ability at each revolution to re-synchronize the actual number of the winding with its number, calculated by the numerical converter 14.

When the pole winding I_i is placed opposite the first 4 and the second 5 filter condenser lenses, an optical beam is formed on them, which is formed as a result of thermal radiation of the pole winding I_i . On the first 4 and second 5 filtering condenser lenses, the narrow spectral ranges of the optical beam emitted by the pole winding 1i are cut out. There is also a concentration of cut rays on the first 6 and second 7 photodetectors, which convert the intensity of light rays into proportional levels of DC voltage, which from the output of the first 6 and second 7 photodetectors are received, respectively, on the first 8 and second 9 amplifiers, where amplified to a level suitable for processing by the digital part of the measuring system. From the output of the first 8 and second 9 normalizing amplifiers, the amplified signal is fed to the first inputs, respectively, the first 10 and second 11 blocks of analog memory, where they are stored when the signal of the logic unit to their second inputs. From the outputs of the first 10 and second 11 blocks of analog memory, the stored voltage level is fed to the first and second information inputs of the multiplexer 12, the output of which transmits a signal from the first or second information inputs, depending on the logic signal supplied to its address input from the second output of the numeric converter 14.

After receiving a single signal at its second input, the numeric converter 14 with some time delay generates a logic unit signal at its first output, which serves as a control signal to start analog-to-digital conversion of the voltage level from the output of the multiplexer 12. Upon completion of the analog-to-digital conversion of the signal at the first input of the multiplexer 12, the proportional numerical code from its output of the analog-to-numeric converter 13 is fed to the first input of the numeric converter 14, where it is read into memory. After reading a numeric code proportional to the signal at the first input of the multiplexer 12, the signal at the second output of the numeric converter 14 connected to the address input of the multiplexer 12 is changed. After that, the output of the multiplexer 12 is fed a signal from its second input and repeats the process of analog-to-numeric conversion and reading a numeric code proportional to the signal at the second input of the multiplexer 12, similarly to the signal coming to the first input of the multiplexer. Upon completion of analog-to-digital conversions, the second output of the numeric converter 14 goes to the initial position. And in the numerical converter 14 is the calculation of the temperature of the i_{th} pole winding I_i , which allows you to remove the component of error associated with the most significant non-informative effects.

The numerical converter 14 through the communication line 15, which is connected to the first input-output of the numerical converter 14, is connected to the server 16. Through the communication line 15 from the numerical converter 14 to the server 16 is transmitted measured temperature and winding number to which it corresponds. Whereas from the server 16 to the digital converter 14 receives start/stop signals of the measuring system and service commands to control the process of transmitting measuring information.

Results

1. A bispectral pyrometric method of temperature measurement is proposed, which provides simultaneous conversion into voltage of functionally temperature-dependent spectral densities of radiation for two spectrally close electromagnetic waves with subsequent finding of their ratio, which allowed removing the most significant components of methodical measurement characteristic of classical pyrometers. A mathematical model is obtained, which unambiguously connects the ratio of voltages at

the output of two optical channels with the temperature of the object of measurement. It is shown that this method is characterized by a sufficiently high sensitivity and accuracy when measuring temperature in the middle range of values.

2. It is shown that the sensitivity module of the measuring instrument implemented on the basis of the proposed bispectral pyrometric measurement method will increase with increasing absolute difference between the lengths of the studied electromagnetic waves, this effect will be accompanied by increasing nonlinearity of its static characteristics. In particular, at the lengths of the studied electromagnetic waves $\lambda_1 = 10 \mu\text{m}$ and $\lambda_2 = 8 \mu\text{m}$ and the measuring range from 310 K to 460 K (which corresponds to the typical operating conditions of the windings of rotating electric machines) the nonlinearity error will approach 3% and the sensitivity will be in the range $-3.923 \cdot 10^{-3} \text{ K}^{-1}$ to $-1.22 \cdot 10^{-3} \text{ K}^{-1}$. Whereas at the lengths of the studied electromagnetic waves $\lambda_1 = 10 \mu\text{m}$ and $\lambda_2 = 6 \mu\text{m}$ and the specified measurement range, the error of nonlinearity will approach 12 %, and the sensitivity will be in the range from $-17 \cdot 10^{-3} \text{ K}^{-1}$ to $-2.846 \cdot 10^{-3} \text{ K}^{-1}$.

3. The design of the temperature system of pole windings of a rotor of rotating electric machines realized on the basis of the offered method of measurement of bispectral pyrometric measuring system is developed. It is shown that the specified bispectral pyrometric measuring system is suitable for operation in conjunction with technical condition monitoring and diagnostic systems.

Conclusions

The proposed bispectral pyrometric method of temperature measurement is characterized by sufficient accuracy and sensitivity in the middle range of values. On its basis, developed a block diagram of a bispectral pyrometric measuring system designed to work in conjunction with systems for monitoring the technical condition and diagnosis of electrical machines. It is shown that the use of the proposed bispectral pyrometric measuring system can increase the efficiency of technical condition monitoring and diagnostic systems by increasing the accuracy of measuring the temperature of the rotor pole windings in real time.

Література

1. Cardoso A.J.M. Diagnosis and Fault Tolerance of Electrical Machines, Power Electronics and Drives. Covilha. The Institution of Engineering and Technology, 2018. 349 p.
2. Граняк В.Ф., Кухарчук В.В., Каців С.Ш. Параметричний ємнісний вимірювальний перетворювач повітряного зазору. *Вісник Вінницького політехнічного інституту*. 2020. № 6. С. 7–15.
3. Посудін Ю.І. Фізика і біофізика навколишнього середовища. Київ : Світ, 2000. 303 с.
4. Shuanglong C., Bojun S. Xiaogang S. A method for improving temperature measurement accuracy on an infrared thermometer for the ambient temperature field. *Review of Scientific Instruments*. 2020. № 91. 8 p.
5. Ross-Pinnock D., Maropoulos P.G. Review of industrial temperature measurement technologies and research priorities for the thermal characterisation of the factories of the future. *Journal of Engineering Manufacture*. 2015. № 27. 14 p.
6. Електричні машини і трансформатори: навчальний посібник / М.О. Осташевський та ін.; за заг. ред. д.т.н., професора В. І. Мілих. Київ: Каравела, 2018. 452 с.
7. Kukharchuk V.V., Hraniak V.F., Vedmitskyi Y.G. Noncontact method of temperature measurement based on the phenomenon of the luminophor temperature decreasing. *Proc. SPIE 10031, Photonics Applications in Astronomy, Communications, Industry, and High-Energy Physics Experiments*. 2016. 6 p.
8. Брао І. Аналіз проблематики та перспективних напрямів розвитку безконтактної термометрії. *Вимірювальна техніка та метрологія*. 2014. № 75. С. 40–44.
9. Русин С.П. Определение температуры и излучательной способности непрозрачных нагретых тел по спектру теплового излучения: моделирование измерений в спектральном окне. *Теплофизика и аэромеханика*. 2011. № 4. С. 629–641.
10. Лукіянець Б.А., Понеділок Г.В., Рудавський Ю.К. Основи квантової фізики: навчальний посібник. Львів : Видавництво Львівської політехніки, 2009. 420 с.

11. Гоц Н., Засименко В. Математична модель функціонування скануючої системи вимірювання температури рухомих об'єктів. *Вимірвальна техніка та метрологія*. 2001. № 58. С. 75–78.

References

1. Cardoso, A.J.M. (2018) *Diagnosis and Fault Tolerance of Electrical Machines, Power Electronics and Drives*. Covilha. The Institution of Engineering and Technology.
2. Hraniak, V.F., Kukharchuk, V.V., & Katsiv, S.Sh. (2020). Parametric capacitive measuring transducer of air gap. *Bulletin of Vinnytsia Polytechnic Institute*, 6, 7–15.
3. Posudin, Y.I. (2000). *Physics and biophysics of the environment*. Kyiv: World.
4. Shuanglong, C., Bojun, S., & Xiaogang, S. (2020). A method for improving temperature measurement accuracy on an infrared thermometer for the ambient temperature field. *Review of Scientific Instruments*, 91, 8 p. DOI: 10.1063/1.5121214.
5. Ross-Pinnock, D., & Maropoulos, P.G. (2015). Review of industrial temperature measurement technologies and research priorities for the thermal characterisation of the factories of the future. *Journal of Engineering Manufacture*, 27, 14 p.
6. Ostashevsky, M.O., et al. (2018). V.I. Milyh (Ed.) *Electrical machines and transformers: textbook*. Kyiv: Caravel.
7. Kukharchuk, V.V., Hraniak, V.F., & Vedmitskiy, Y.G. (2016). Noncontact method of temperature measurement based on the phenomenon of the luminophor temperature decreasing *Proc. SPIE 10031, Photonics Applications in Astronomy, Communications, Industry, and High-Energy Physics Experiments*, 24–30.
8. Brao, I. (2014). Analysis of issues and promising areas of contactless thermometry. *Measuring equipment and metrology*, 75, 40–44.
9. Rusin, S.P. (2011). Determination of temperature and emissivity of opaque heated bodies by the spectrum of thermal radiation: simulation of measurements in the spectral window. *Thermal physics and aeromechanics*, 4, 629–641.
10. Lukyanets, B.A., Ponedilok, G.V., & Rudavskiy, Y.K.. (2009). *Fundamentals of quantum physics: textbook*. Lviv: Lviv Polytechnic Publishing House.
11. Gots, N., & Zasimenko, V. (2001). Mathematical model of functioning of the scanning system for measuring the temperature of moving objects. *Measuring equipment and metrology*, 58, 75–78.

Граняк Валерій Федорович; Hraniak Valerii, ORCID: <https://orcid.org/0000-0001-6604-6157>

Received March 18, 2021

Accepted May 13, 2021